

GSM/GPRS/GPS Tracker User Manual



Preface

Thank you for purchasing the tracker. This manual shows how to operate the device smoothly and correctly. Make sure to read this manual carefully before using this product. Please note that specification and information are subject to changes without prior notice in this manual. Any change will be integrated in the latest release. The manufacturer assumes no responsibility for any errors or omissions in this document.

Contents

1. Summary.....	4
2. Applications.....	4
3. Hardware Description.....	4
4. Accessories.....	5
5. Specifications.....	6
6. Terminal Installation.....	6
6.1. Terminal Installation.....	6
6.2. SIM CARD Installations.....	7
6.3. Turn on the Tracker Device.....	7
6.4. GSM/GPS LED Indicator.....	7
6.5. Initialization.....	8
6.6. Change Password.....	8
6.7. Authorization.....	8
6.8. Single Locating.....	8
6.9. Auto track continuously.....	9
6.10. Turning points update automatically.....	9
6.11. GPS drift suppression.....	10
6.12. Exact street address.....	10
6.13. Location based service (LBS) / Cell-ID Locating.....	10
6.14. Monitor.....	10
6.15. Data logging.....	11
6.16. Data Load.....	11
6.17. Forward the third parties' message.....	11
6.18. SIM card Balance Inquiry.....	12
6.19. ACC working alarm.....	12
6.20. Cut off the oil and power system.....	12
6.21. Calibration of fuel sensor.....	13
6.22. Function of Remote Controller (Option, for model G ONLY).....	13
6.23. Arm.....	13
6.24. Silent Mode.....	14
6.25. DISARM.....	14
6.26. Decide how many times of alarm message.....	14
6.27. Alarm Function.....	15
6.27.1. Low battery alarm.....	15
6.27.2. External Power off alarm.....	15
6.27.3. GPS blind Spot alert.....	15
6.27.4. SOS.....	15
6.27.5. Geo-fence.....	15
6.27.6. Multi-area managerment.....	16
6.27.7. Movement alarm.....	16

6.27.8.	Overspeed alarm.....	16
6.27.9.	Fuel Alarm.....	17
6.28.	Alarms under Arm State.....	17
6.28.1.	Door Open Alarm.....	17
6.28.2.	ACC Alarm.....	17
6.28.3.	Built in Acceleration Sensor Alarm.....	17
6.28.4.	Alarm without GSM network service.....	18
6.29.	Sleep Mode.....	18
6.29.1.	Sleep by time.....	18
6.29.2.	Sleep by shock sensor.....	18
6.29.3.	Deep Sleep by Shock Sensor.....	18
6.29.4.	No sleep mode.....	18
6.30.	Start Work on specific time.....	19
6.31.	Check the Vehicle State.....	19
6.32.	Check IMEI.....	19
6.33.	Set up Terminal (local) Time.....	19
6.34.	Reset Hardware.....	20
6.35.	Configure parameters by USB.....	20
6.36.	GPRS setting.....	20
6.37.	Less GPRS traffic.....	21
6.38.	Activate "Fuel" value in GPRS data.....	21
6.39.	Set up monitor center number.....	21
6.40.	Instructions for web platform and mobile APP.....	22
7.	Cautions.....	24
8.	Faults & the Solutions.....	25

1. Summary

1.1 Working Based on existing GSM/GPRS network and GPS satellites, Set multiple functions of security, tracking, monitoring surveillance, emergency alarms and management , this product can locate and monitor any remote targets by SMS or internet.

1.2 Features

- 1.2.1 Built-in GSM, GPS antenna, compact, elegant appearance.
- 1.2.2 Support GPS and LBS (Location based service) double tracking solutions.
- 1.2.3 Support SMS/GPRS/Internet Network data transmission
- 1.2.4 Support configure the settings remotely
- 1.2.5 Set multiple functions of security, tracking, monitoring surveillance, emergency alarms and management in its entirety.

2. Applications

Used widely for vehicle and other moving objects tracking.

3. Hardware Description



4. Accessories

No.	Photo	Name	Specifications	Applicable model
1		Harness	12PIN	Standard
2		Microphone	1.5m	Standard
3		Relay	12V/40A or 24V/40A	Standard
4		siren	12V/24V	Optional
5		Fuel sensor		Optional
6		Remote control		Optional for type G

5. Specifications

Content	Specification
DIM	9.6×5.3×1.6cm
Weight	70g
Network	GSM/GPRS
Band	850/900/1800/1900Mhz
GPS sensitivity	-159dBm
GPS accuracy	5m
GPS start time	Cold status 45s Warm status 35s Hot status 1s
Car power supply	12 V -24V
Back up battery	Chargeable 3.7V 700mAh Li-ion battery
Storage Temp	-40°C to +85°C
Operation Temp.	-20°C to +65°C
Humidity	5%--95% non-condensing

6. Terminal Installation

6.1. Terminal Installation

- 6.1.1 Please ask the qualified engineers to install it.
- 6.1.2 Do not install it in an environment which is over GSM performance index.
- 6.1.3 Pay attention to make installation location preventing water and dust.
- 6.1.4 Find the 12 PIN harness and insert it into the corresponding holes of the products, and connect the wires with the original car circuit showing below:

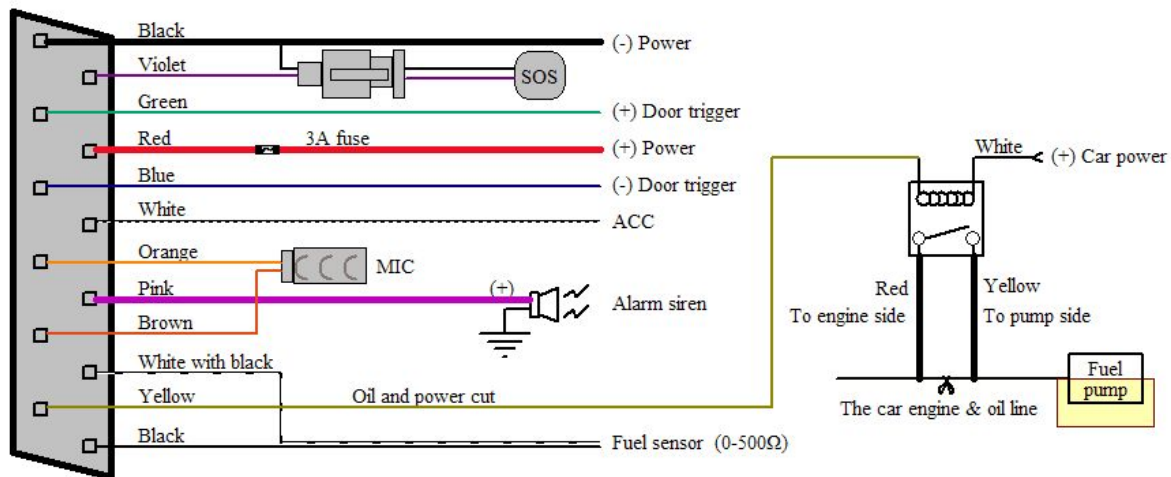

Wiring diagram

6.1.5 Note: The pink wire can be connected to the original car horn; it can also be connected to the siren bought with the tracker.

6.1.6 Know about the type of the door trigger is positive or negative trigger. Please connect the green wire to the door control circuit if it is positive, and connect blue wire if it is negative.

6.1.7 Please install the SOS button on the place driver can touch.

6.2. SIM CARD Installations

6.2.1 Use the screwdriver accompanied with the device to open sealed buckle and insert the SIM card. If need data logging function, please insert microSD and put sealed buckle back.

6.2.2 Please make sure the SIM card is for GSM network and able to execute the function of incoming calls display, no calls can be diverted and the PIN code is locked. The SMS format must be TXT format, and can't recognize the PDU format.

6.3. Turn on the Tracker Device

Connect the positive & negative wire, red & black ones, with 12V or 24V car power system, wait for 1 minute after connecting power to wait tracker works normal, and then turn on the backup battery switch.

6.4. GSM/GPS LED Indicator

Red LED: when charging, LED ON, after full charged, LED OFF,

In Low power, LED flashes fast.

Green LED: In GSM Mode, LED quick flash for each second, In GPRS Mode, LED flash one time in three seconds, when No GSM reception, LED ON.

Blue LED: In good GPS reception, LED quick flash for each second,
No GPS reception, LED OFF.

6.5. Initialization

Send SMS “begin+password” to the unit, it will reply “begin ok” and initialize all the settings to default factory settings. (default password: 123456)

For example: send SMS “begin123456”, it will reply “begin ok”.

6.6. Change Password

6.6.1. Send SMS “ password+old password+space+new password” to the unit to change the password.

For example: send SMS “password123456 888888” to the unit. If succeeded, “password ok” will reply to your cell phone from the device tracker.

6.6.2. Be sure to keep the new password in mind, you have to upload the software to restore the original setting in case of losing the new password.

6.6.3. Attention: Make sure the new password is in 6 digits Arabic numbers, or else the tracker cannot recognize the password.

6.6.4. When reading this user manual, you will notice that we have used "+" and "space" between some words;"+" between two words means they should be written together as one word and "space" between two words means you should leave one character space between two words.

6.7. Authorization

Up to 5 numbers can be authorized.

6.7.1. Call the tracker for 10 times continuously and get its position, then it will save the cell phone number as the authorized number automatically. and reply “add master ok”.

6.7.2. Authorization: Send SMS “admin+password+space+cell phone number” to set up an authorized number, the other authorized numbers should be set by the first authorized number, if the number is successfully authorized, the unit will reply “admin OK” by SMS.

6.7.3. Delete authorization: Send SMS “noadmin+password+space+authorized number” to delete the authorized number.

6.7.4. If you want to track the target when it enters into another country, you must add the country code before the cell phone number. You should authorize your number in international format as follows: “admin123456 008613322221111” to tracker to set 13322221111 as an authorized number.

6.8. Single Locating

6.8.1. If there aren't any authorized number set-up, it will reply all calls with a location report; if there are authorized numbers set-up, then it will not respond when an unauthorized number calls it.

6.8.2. If you call it from authorized phone number, it will hang up and report a real-time location as below:



When lost fix to satellites, it will track by LBS / CELL-ID. And the SMS will include two positions:

- GPS coordinates of the last known position.
- LAC code. Open web platform and find “manual track”, put code received from tracker in LAC and Cell-ID fields to locate by LBS technology.

6.9. Auto track continuously

6.9.1. Track with limited times upon time interval

Send SMS command “fix030s005n+password” to the tracker device, it will report the latitude & longitude at intervals of 30 seconds for 5 times. (s:second, m:minute, h:hour). This command set must be in 3 digits Arabic numbers and the maximum value is 255.

e.g. fix030s005n123456

6.9.2. Track with unlimited times upon time interval

Send SMS “fix030s030m***n+password” to the tracker. Tracker will report a real-time location every 30 seconds when ACC is ON, and report every 30 minutes when ACC is OFF.

Note: The interval must not less than 10s.

6.9.3. Smart track upon time and distance interval

6.9.3.1. Please set "track with unlimited times upon time interval" before this function, and send "distance+password+space+distance", tracker will reply "Distance ok", and then tracker will locate upon both the pre-set time and distance.

e.g. Send "distance123456 0050", it means distance is 50 meters; the number must be 4 digits Arabic numbers.

6.9.3.2. Set this function on web platform: Set time interval first and then distance interval, tracker will locate upon the time and distance.

6.9.4. Cancel: Send SMS “nofix+password” to the tracker device to cancel the “auto track”.

e.g. nofix123456

6.10. Turning points update automatically

6.10.1 The tracker will update the positions automatically to web platform once the vehicle changing driving direction over pre set angle value to form a smooth trajectory consistent with the actual road, this function is only effective in GPRS mode.

6.10.2 Send "angle+password+space+angle" to tracker, it will reply" angle ok". e.g. angle123456
040

6.10.3 The angle must be 3 digits Arabic numbers, default angle value is 30 degree.

6.11. GPS drift suppression

6.11.1 This function is deactivated by default, send "suppress+password" to tracker, it will reply" suppress drift ok". The GPS data stop updating if vehicle is not driving (ACC is OFF) and latitude and longitude always keep same, and GPS data updates automatically when vehicle is moving.

6.11.2 Cancel: send "nosuppress+password" to tracker, it will reply" nosuppress ok ".

6.12. Exact street address

6.12.1 You must set up the APN of your local GSM network for the SIM card in tracker first before using this function, if there is user name and password for GPRS login, (Please refer to 6.36 to configure the APN, user name and password for GPRS login.)

6.12.2 After configure the APN, send "address+password" to device, it will reply SMS including real street/address name. For example: No.113, Guankou 2nd Rd, Nantou, Nanshan district, Shenzhen, Guangdong, china. e.g. address123456

6.13. Location based service (LBS) / Cell-ID Locating

If the tracker cannot establish a solid GPS Fix, it will calculate its location using Cell-ID GSM locating, Location reports will include the GPS coordinates of the last known positions as well as a LAC code, Entering the LAC code to the “Manual Track” menu of web tracking platform www.gpstrackerxy.com will enable you to see the tracker’s current location. You can also send command “address+password” to the tracker to request exact address, track will automatically switch to tracking by LBS in GPRS mode. Accuracy of LBS depends on the distance to the nearest GSM Network Cell Tower or Base Station.

Note: This feature can be used normally in most areas according to the signal of GSM network. It may not be available in some areas.

6.14. Monitor

6.14.1 The command to switch between Track mode and Monitor mode are “tracker” and “monitor”.

The default mode is “track” (Track mode).

6.14.2 Send SMS “monitor+password” to the unit, and it will reply “monitor ok!” and switch to “monitor” mode.

6.14.3 Send SMS “tracker+password” to the unit, and it will reply “track ok!” and switch to “track” mode.

6.15. Data logging

6.15.1 Auto logging: When the tracker device lost GSM signals or fall offline from GPRS, tracker will log the tracking position and alerts automatically in the SD card on the basis of the pre-set condition, when GSM signals get back, all the event alerts will be auto-sent to the authorized numbers or web platform (server), but the logged tracking data should be loaded to the web platform via SMS command.

6.15.2 Logging upon times: Send SMS: “save030s005n+password” to the tracker unit, it will reply “save ok”, and will log the Latitude and longitude locations every 30 seconds for 5 times. (S: second, m: minute; h: hour).

6.15.3 Multi-logging: Send SMS:”save030s***n+password” to tracker device, it will reply “save ok”.

6.15.4 Cancel logging: Send SMS “nosave+password”, e.g. nosave123456

6.15.5 Logging Clearance: send SMS: “clear+password” to tracker device, it will reply “clear ok”.

6.15.6 Logging Volume: It depends on the capacity of the SD card inserted in the tracker device.

6.15.7 The logged data in SD card can be copied to computers through card reader, and then the data route can be checked by importing data in the menu “Data Import” of web platform www.gpstrackerxy.com

6.16. Data Load

6.16.1 Current date Load: Send SMS: “load+ password” to tracker device, it will reply: “load ok” if the device is working well under GPRS mode; if not, it will reply “load fail! Please check gprs” that means device does not work under GPRS mode.

6.16.2 Specified date Load: Send SMS: “load+ password+ space+ year month date” to tracker device, it will reply: “load ok” and load the tracking data to the web platform upon the valid time you choose. For Example: send SMS: “load123456 20110425” to the tracker device, means to load the tracking data of 25th April 2011 to web platform.

6.17. Forward the third parties’ message

6.17.1 Send SMS "forward+password+space+third parties phone number" from authorized phone number, tracker will reply"forward ok", and supports 1 third parties phone numbers at most. For example, set the phone number of the service provider of the SIM card in the tracker, when charge remind message coming in, tracker will forward it to authorized phone number.

6.17.2 Cancel: Send SMS command "noforward+password".

6.18. SIM card Balance Inquiry

Send SMS command "balance+password+space+carrier's phone number+space+code" to tracker, it will forward the code to carrier's phone number and return the balance message received from carrier's phone number

How it works: After accept balance command, tracker will remember the "mobile phone number", carrier's phone number and the code;

And then send the code to carrier's phone number, and forward the message from carrier to mobile phone number.

Take china mobile for example, mobile users can send "ye" to china mobile number 10086, and 10086 will send user's balance message to tracker, and then tracker forward the balance message to mobile phone number, following is an illustration how this function works.

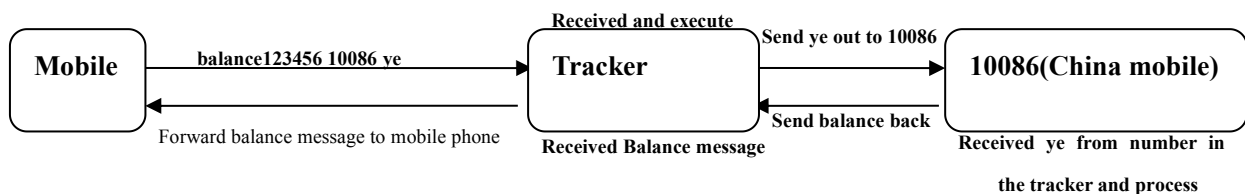

6.19. ACC working alarm

6.19.1 This function is deactivated by default. To active this functions, send "ACC+password" to tracker, it will reply "ACC ok". And tracker will send "ACC on+latitude & longitude" to authorized numbers when detect ignition on, that means the vehicle has been started; and tracker will send "ACC off+latitude & longitude" to authorized numbers when ignition off and ACC is off, that means vehicles has been stopped.

6.19.2 Send "noACC+password" to deactivate this function, tracker will reply "noACC ok"

6.19.3 This configuration can only activate and deactivate the alarm to authorized numbers; it will send to web platform automatically in GPRS mode and can't be deactivated

6.20. Cut off the oil and power system

6.20.1 Send command "stop+password" to tracker, tracker will execute it and reply "Stop engine Succeed". And it will remain immobile state until next command to resume.

6.20.2 Stop mode

Execute immediately: Send command "quickstop+password" to tracker, it will reply "quickstop OK". Then tracker will stop the car immediately after "stop" command.

Execute depends on speed(Default mode): Send command "noquickstop+password" to tracker, It will reply "noquickstop OK", Then the tracker won't stop the car immediately after "stop" command, instead, it will reply "it will be executed after speed less than 20KM/H", and stop the car when the speed is less than 20KM/H.

6.20.3 Resume the Oil and Power System

Send “resume+password” to tracker, it will reply "Resume engine succeed", it means the oil supply is resumed.

6.21. Calibration of fuel sensor







6.21.1 Due to the difference of fuel tank height and resistive fuel level sensor specifications, tracker need to set an appropriate zero value and full range value to detect the precise fuel percentage.

6.21.2 Zero calibration: Send “ oilzero+password “ to tracker when the fuel tank is empty , tracker will adjust zero and reply “ oilzero ok!” . The fuel check is 0%.

6.21.3 Full calibration: Send “oilfull+password “ to tracker when the fuel tank is full , then tracker will adjust the full range and reply “ oilfull ok! “ . The fuel check is 100%.

6.21.4 Tracker can connect to car original resistive fuel level sensor ranging from 0-500OHM. You can also connect add-on resistive fuel level sensor.

6.22. Function of Remote Controller (Option, for model G ONLY)

Button	Function	Descriptions
	ARM	Press for 0.5 second, the siren will beep one time.
	DISARM	Press for 0.5 second, the siren will beep two times.
	ARM & Silent mode	Press for 0.5 second when it is in disarm state, the siren will beep one times. No voice from siren when alarm triggered and quit from silent mode automatically when disarm.
	SOS	Press for 3 seconds, Tracker will send SOS alert to authorized phone numbers without voice.
	Deterrence/car search	Press for 0.5 second when it is in arm state, siren will beep 10 seconds, press disarm button  to quit.

6.23. Arm

6.23.1 Set up arm by SMS

Send “arm+password” to tracker, it will make the car enter ARM states and and reply “Tracker is activated”.

If the car is in ignition (ACC is at “ON” position), then the car can’t enter ARM state, reply “set up fail! pls turn off ACC”.

If engine turned off, but door is open, then the car can’t enter ARM state and reply “set up fail! pls close the door”.

6.23.2 Set up arm by remote controller (Option, for model G ONLY)

Press  button on the remote controller for 0.5 seconds, the car enters into armed state and the siren will beep one time, no SMS reply.

If the car is in ignition (ACC is at “ON” position), then the car can’t enter ARM state, and siren keep silent.

If engine turned off, but door is open, then the car can’t enter ARM state and siren beeps 3 times, that means door is not closed.

6.24. Silent Mode

6.24.1 Set up silent mode by SMS

Send silent+password to tracker, it will reply silent ok! that means tracker enters ARM & silent mode, Siren won’t be sound after alarm is triggered, but tracker will send alarm SMS to authorized number.

Send disarm+password to quit ARM & silent mode.

6.24.2 Set up silent mode by remote controller (Option for model G)

Press  in disarm state for 0.5 second, the siren will beep one time, the car will enter ARM & Silent mode. Siren won’t be sound after alarm is triggered, but tracker will send alarm SMS to authorized numbers.

Press  to quit.

6.25. DISARM

6.25.1 DISARM BY SMS

Send command “disarm+password” to tracker, tracker will disarm and reply “Tracker is deactivated”, then it will turn off the alarm of door, shock sensor and ACC, and no alarms if open door, trigger shock sensor and ignition.

6.25.2 DISARM BY Remote controller (Option for model G)

Press  on remote controller for 0.5 seconds, the car will enter DISARM state and, siren beeps two times and tracker doesn’t send message.

6.26. Decide how many times of alarm message

You can decide how many times of the alarm message to be sent, For those alarm message sent in cycle, you can limit the times the alarm message to be sent. send SMS “ xtime+password+005 “ to tracker, alarm message will be sent 5 times once alarms are triggered .

The Alarm SMS will be sent 5 times by default.

6.27. Alarm Function

6.27.1. Low battery alarm

Send SMS “lowbattery+password+space+on”, it will send SMS “low battery+latitude/longitude” to authorized numbers 2 times in total in **15 minutes interval** when voltage of battery is going to be about 3.55V.

This function activates by default, send SMS “lowbattery+password+space+off” to deactivate.

6.27.2. External Power off alarm

This function activates by default. Send “ extpower+password+space+on” to activate, it will send SMS “power alarm+latitude/longitude” to authorized numbers every 3 minutes when external power is cut off.

Cancel: Send SMS “ extpower+password+space+off” to deactivate it.

6.27.3. GPS blind Spot alert

This function deactivates by default, send SMS “gpssignal+password+space+on”, it will send alert SMS “no gps+last valid latitude/longitude before lost signal” when no GPS signal is received.

Send SMS “gpssignal+password+space+off” to deactivate.

6.27.4. SOS

Long Press the SOS button for 3 seconds (For model G, press  button on remote controller for 3 seconds) , the tracker device will send SMS “help me!+lat./long.” to all the authorized numbers at interval of 3 minutes. It will stop sending such an alert SMS when any authorized number reply SMS “help me” to the tracker.

6.27.5. Geo-fence

Set up a geo-fence for the tracker device to restrict its movements within a district. The tracker will send SMS to the authorized numbers when it goes out of this district.

Set up: When the car stays immobile in a place for 3-10 minutes, the user can send SMS“stockade+password+space+latitude, longitude;latitude,longitude” to unit to set the restricted district. In case of breach, it will send SMS “stockade!+ latitude & longitude” to the authorized numbers.

Note: The first latitude & longitude is coordinate of the top left corner of the Geo-fence, while the second latitude & longitude is the coordinate of the bottom right corner, it will alarm at interval of 3 minutes once beyond the restricted district.

Cancel: Send SMS “nostockade+password” to deactivate this function.

6.27.6. Multi-area management

6.27.6.1 Set area

Send SMS command "area+password+space+latitude,longitude+space+areaname,distanceM" to tracker(distance unit: M for meter, K for kilometer), it will reply "area01 ok". For Example: Send "area123456 22.353648,113.543678 school,800M".

Note: 5 areas at most and the distance between two points can't be less than the total distance in the 2 commands, and different areas can't cover each other

6.27.6.2 Delete area

Send SMS command:"noarea+password+space+area name" to tracker, it will reply:"noarea ok".

6.27.6.3 rename and set distance

Send SMS command "rename+password+space+old name;new name,distanceM" to tracker, if name is not repeated and area doesn't cover others, it will reply "rename ok!" for successful configuration.

Example: Send"rename123456 area01;school,800M", it means the new area name is "school", and covers area of a radius of 800 meters.

6.27.6.4 Activate multi-area management

Send SMS command "area+password+space+on" to tracker, it will reply "Area on ok!", when tracker enter the pre-set area, it will send SMS "area name+latitude & longitude" to all the authorized phone number, and send same SMS when goes out of the area.

6.27.6.5 Deactivate Multi-area management

Send SMS command "area+password+space+off" to tracker, it will reply"area off ok!"

6.27.7. Movement alarm

Set up: when the unit stays immobile in a place for 3-10 minutes with GPS signal reception, the user can send SMS“move+password+space+0200” to the tracker (Suppose area of a radius of 200 meters, it supports 4 digits at most. Unit: Meter). It will reply “move OK”. In case of such a movement (the default distance is 200m), it will send SMS “Move+ latitude & longitude” to the authorized numbers **at interval of 3 minutes**.

Cancel: Send SMS “nomove+password” to deactivate the movement alarm.

6.27.8. Overspeed alarm

Set up: Send SMS command “speed+password+space+080” to the unit (suppose the speed is 80km/h), and it will reply “speed OK!”. When the target moves exceeding 80km/h, the unit will send SMS

“speed+080!+ latitude & longitude” to the authorized numbers ,it will only send one SMS in 3 minutes in SMS mode when overspeed ; the siren will beep 1 time when overspeed 1 time.

Cancel: Send SMS “nospeed+password” to deactivate the overspeed alarm.

Note: The recommended speed should be not less than 30km/h. For below that rate, it will be effected the accuracy by GPS signals drift etc.

6.27.9. Fuel Alarm

When the fuel consumption exceeds the normal standards during driving, or oil theft/leakage when the vehicle is stopped, the tracker will send "oil: xx% + Geo-info" to the authorized number at interval of 3 minutes. The siren beeps 20S.

Cancel: Send SMS command “ nooil+password” to tracker.

6.28. Alarms under Arm State

6.28.1. Door Open Alarm

The unit will send SMS “Door alarm+lat/long” to the authorized number at interval of 3 minutes when the door of the car opens in arm status. Siren will be sound for 20 seconds, and repeat sound at interval of 20 seconds if the door is always open. Disarm to stop this alarm

6.28.2. ACC Alarm

The unit will send SMS “ACC alarm+lat/long” to the authorized number in at interval of 3 minutes when the engine of the car is turned on, that is the key is rotated to “ACC ON” position to start the car in arm state; Siren will be sound for 20 seconds, and repeat again at interval of 20 seconds if the ACC always keep ON. Disarm to stop this alarm.

6.28.3. Built in Acceleration Sensor Alarm

6.28.3.1 The tracker is built in three axis acceleration sensor, the tracker can detect it in arm state when the vehicle move, tilt or shock. The alarm way is the same as the external shock sensor alarm.

Disarm to stop this alarm.

6.28.3.2 The sensitivity of the built-in shock sensor has three different level:

First level: Alarm will be triggered after detect one time slight vibration,

send command" sensitivity+password+space+1" .

Second level: Alarm will be triggered after detect 8 times vibration in 2 seconds, send command" sensitivity+password+space+2".

Third level: Alarm will be triggered after detect 25 times vibration in 5 seconds, send command" sensitivity+password+space+3".

6.28.4. Alarm without GSM network service

When the car is arm state and in the place without GSM network service, siren will be sound under non-silent mode if alarm is triggered (door, sensor, ACC), but no SMS alarm will send to authorized number.

6.29. Sleep Mode

6.29.1. Sleep by time

Send SMS command "sleep+password+space+time" to tracker device, tracker will reply "sleep time ok" if none of the alarms has been set and no operations, tracker will fall asleep in 5 minutes, GPS module shuts down, LED will be off ,calling or SMS can awake the tracker. If these alarms have been set, tracker will sleep by detecting shock sensor.

E.g sleep123456 time.

6.29.2. Sleep by shock sensor

Send SMS command "sleep+password+space+shock"to tracker device, tracker will reply "sleep shock ok", it will enter sleep mode if no shake is detected and ACC is off , GPS module shuts down, LED will be off . Shake or any operation can awake the tracker.

6.29.3. Deep Sleep by Shock Sensor

Send SMS command "sleep+password+space+deepshock"to tracker to activate deep sleep by shock sensor, it will reply "sleep deepshock ok", and will enter deep sleep mode if no vibration is detected, GPS and GSM module shuts down, it will run in supper lowest power consumption mode. Vibration or any operation can't awake the tracker. Alarms can be triggered normally, after alarm cancelled, tracker come back to deep sleep mode again.

6.29.4. No sleep mode

Send SMS command"sleep+password+space+off" to tracker device , tracker will reply"sleep off ok". Tracker GSM, GPS, LED will work without sleep .This mode is the default mode.

6.30. Start Work on specific time

Send "schedule+password+space+1h"to tracker, it will awake every one hour and send position info. (m:minute,h:hour,d:day) The time interval is in 3 digits at most and should be less than 30days. GSM & GPS module shut off, trackers work under low power consumption mode. Neither calling nor SMS can awake tracker device. Track will be awoken by alarms and enter to this mode after alarms are deactivated.

Cancel: After the tracker is waked up. Send SMS command” noschedule+password”to cancel this function.

6.31. Check the Vehicle State

Send SMS command “check+password” to the tracker device in the vehicle, It will reply the status of the power, battery, GPS, ACC, door, GSM signal, GPRS status ,oil, APN, UP, IP and Port to the authorized numbers.

For example: Send SMS “check123456” to the tracker device in the vehicle, It will reply following SMS.

Power: ON/OFF

Battery: 100%

Oil: 100%

GPRS: ON/OFF

GPS: OK/NO GPS

ACC: OFF/ON

Door: OFF/ON

GSM Signal: 1-32 The higher, the better.

APN: cmnet

IP: 104.250.138.146

PORT: 9000

6.32. Check IMEI

Send SMS command "imei+password" to the unit. E.g. Send SMS command "imei123456" to the tracker device, an IMEI number in 15 digits will reply to your cell phone.

6.33. Set up Terminal (local) Time

Send SMS command “time+space+zone+password+space+time” to the tracker unit, If succeed, It will

reply “time OK”

For example: Send SMS “time zone123456 8”, 8 is Chinese time zone, If your country time zone is minus, send SMS “time zone123456 -8”.

6.34. Reset Hardware

Send SMS “reset+password” to tracker device, it will reply “reset ok”. And the GSM module and GPS module in the tracker will be reset.

6.35. Configure parameters by USB

Connect tracker to computer with the optional USB cable, open the memory of the tracker, find and open the initial configuration file with notepad  user_config.ini operate according the instructions.

Note: Correct password is needed every time you configure the tracker.

6.36. GPRS setting

User must send SMS via cell phone to set up IP, port and APN before starting GPRS.

6.36.1 Setting up APN

APN standards for Access Point Name and differs from country to country. For more information about the local APN, inquire with your local GPRS network operator.

Text the tracker a SMS “APN+password + Space + your local APN” via a cell phone and if succeeded in setup, the tracker will return the message “APN OK”.

e.g. send SMS command “APN123456 CMNET”. If succeeded, “APN OK” is returned by the tracker in SMS.

Notes: 123456 refer to password of tracker and CMNET is the APN of China Mobile (One of GSM Operator in China).

6.36.2 GPRS User ID and password Setup

In most countries, the user name and password involving GPRS login are not compulsorily necessary, therefore, the entry can be skipped. For those countries requiring user name and password, please configure as following:

Send SMS “up+password+space+user+space+password”If succeeded, “user,password ok” is returned by

the tracker in SMS.

For example: send SMS “up123456 jonnes 666666” to the tracker, and if succeeded, the tracker returns “user, password OK”

Note: 123456 is tracker device password, jonnes is the user name for GPRS login, 666666 is the password for GPRS login.

6.36.3 IP and port setup

Send SMS as below via a cell phone: adminip +password + Space + IP Address + Space + Port Number. If succeeded, “adminip OK” is returned by the device in SMS.

e.g, Send SMS command “adminip123456 104.250.138.146 9000” to the tracker device, If succeeded, “adminip OK” is returned by the device in SMS.(123456 is default password, 104.250.138.146 is IP, 9000 is port).

6.36.4 Switch to GPRS mode

6.36.4.1 Send SMS “GPRS+password” to the unit, and it will reply “GPRS ok!” it means tracker device has switched to “GPRS” mode.

6.36.4.2 TCP / UDP Switch

Send command: "gprs+password,0,0" switch back to TCP mode, this is the default mode.

Send command:"gprs+password,1,1" switch to UDP mode.

6.36.4.3 Send SMS “SMS+password” to the unit, it will reply “SMS ok!” and restore to “SMS” mode

6.37. Less GPRS traffic

Tracker will change to less GPRS traffic mode after parking 5 minutes,

GPRS disconnect, and connect again when alarm being triggered or vehicle starts driving.

Activate this function: Send "less gprs123456 on", tracker will reply "less gprs on ok".

Deactivate this function: Send "less gprs123456 off", tracker will reply "less gprs off ok".

Note: 123456 is the password of tracker, and replace it with the new if you have changed.

6.38. Activate "Fuel" value in GPRS data

The default format of GPRS data doesn't include "Fuel" value, if you need "Fuel" value, please send “protocol+password 18” to tracker, if succeed, it will reply "protocol 18 ok"; send “protocol+password 12” to change back to default mode, if succeed, it will reply "protocol 12 ok".

6.39. Set up monitor center number

Setup: send command “centernum+password+space+number” to tracker, it will reply “center num ok”. After setup monitor center number, the messages of auto track by sms will be set to this center number, if all alarms need to be sent to this number too, then this center number must be

setup as authorized number.

Cancel: Send “nocenternum+password” to tracker, it will reply “no center num ok”.

6.40. Instructions for web platform and mobile APP

Users need to register an account on www.gpstrackerxy.com before use web or APP platform, account name and password is the same on web/APP platform.

6.40.1. register an account

The screenshot displays the TrackerHome V3.0 website interface. At the top, there is a header with the logo, a language dropdown set to 'English', and a message: "Dear Customers. Any IMEI can be switched among server 1." Below the header, three server options are presented in blue boxes:

- SERVER 1**: IP: 202.104.150.75 PORT: 9000
- SERVER 2**: IP: 202.104.149.227 PORT: 9000
- SERVER 3**: IP: 104.250.138.146 PORT: 9000

A search bar with the placeholder text "Please input IMEI to verify." and a "Search" button is located below the servers. A callout box points to the search bar with the instruction: "1. choose the right server to login in".

Below the search bar, there are two QR codes for mobile app downloads. The left one is for iOS, with instructions: "For IOS Search 'TrackerHome' in App Store." and a "Download" button. The right one is for Android, with instructions: "For Android Please click 'Download' to download, need install Google play Services and Google ServicesFramework." and a "Download" button. A callout box points to the QR codes with the instruction: "2. Validate your IMEI is valid or not".

At the bottom of the page, there is a "User Management" dialog box with the following fields: "User ID:", "Password:", "Password Confirmation:", and "Terminal IMEI:". Below these fields are "Save" and "Clear" buttons. At the bottom of the dialog are "Login" and "Register" buttons. A callout box points to the "Register" button with the instruction: "3. Click 'register'. Pop-up a dialog box, register an account".

6.40.2. Login

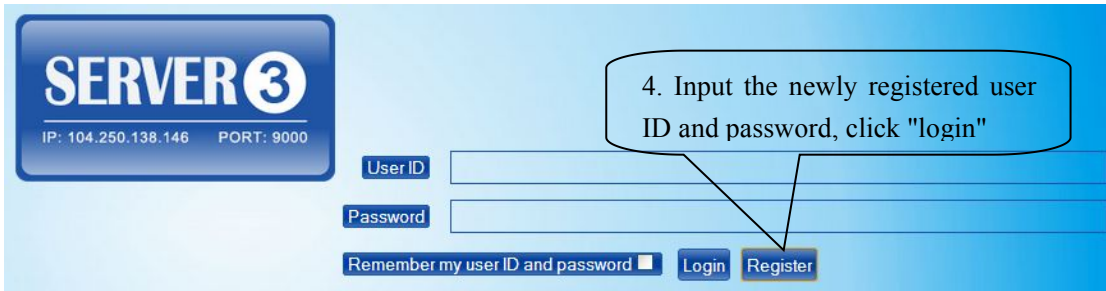

6.40.3. Add a terminal

Name	Date & Time	Description	Speed	Altitude	Oil1	Oil2	°C	ACC	Door	LBS	Latitude	Longitude
Demo	2015-04-16 08:27:01	Position info	0km/h	0.0m	0.0%	0.0%	0	Off	Close	No	22.586880	113.907718
Demo	2015-04-16 08:26:56	Geo fence had been clear.	0km/h	0.0m	0.0%	0.0%	0	Off	Close	No	22.586225	113.90794
Demo	2015-04-16 08:20:56	Position info	0km/h	0.0m	0.0%	0.0%	0	Off	Close	No	22.586225	113.907945
Demo	2015-04-16 08:20:37	Position info	0km/h	0.0m	0.0%	0.0%	0	Off	Close	No	22.586225	113.907945

IMEI NO.	Name	Icon	Model	Group Name	Expiry Date
		Car	All Functions		

6.40.4. Configure your tracker to web platform to track it online

Step 1: set APN, refer to [6.36.1](#)

Step 2: set GPRS user name and password, refer to [6.36.2](#)

Step 3: set IP and port, please use the corresponding IP and port of the server you choose, refer to [6.36.3](#)

Step 4: switch to GPRS mode, refer to [6.36.4](#)

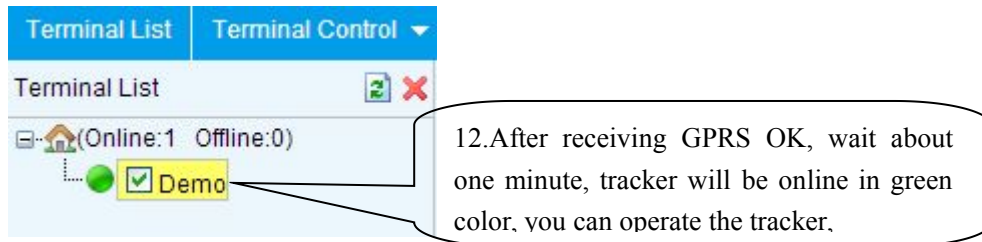

6.40.5. If the tracker is always offline (grey color), make sure the SIM card subscribe the GPRS service, and have money to surf the Internet, you can use phone to test the SIM card can surf the Internet or not.

please check the APN, user name, password, IP, port settings are correct, refer to [6.31](#).

6.40.6. IOS & Android mobile APP

6.40.6.1. Download and install the mobile APP software

According to your phone type, download and install mobile app below the home page on web tracking platform.



6.40.6.2. login in and use the mobile APP

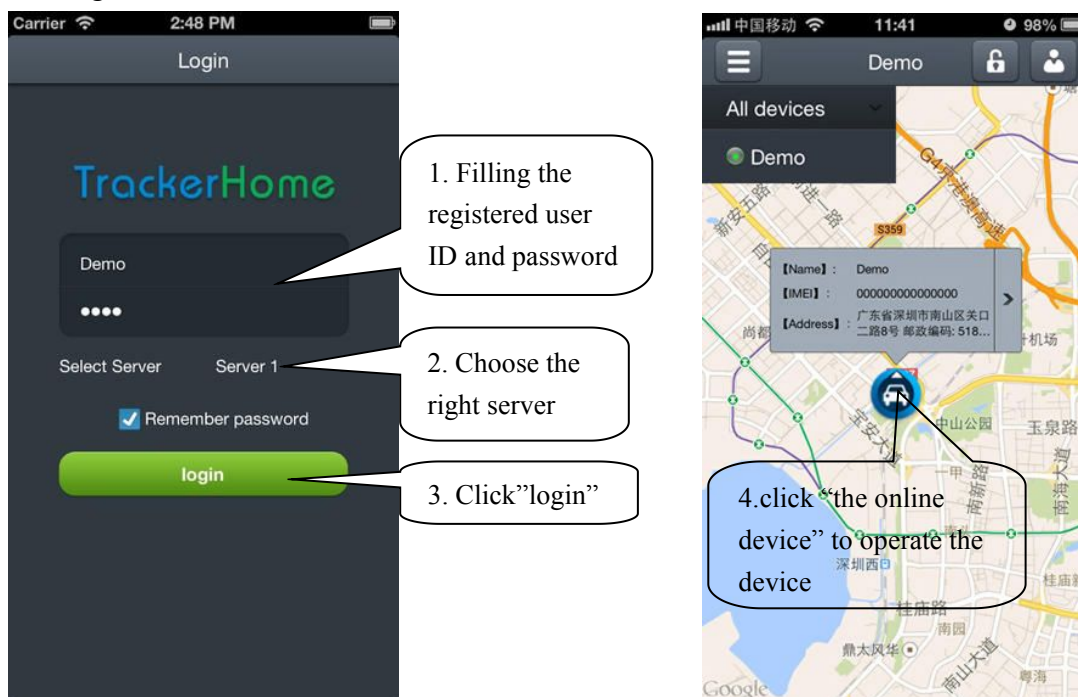

7. Cautions

Please comply with the instructions to extend the unit life:

1. Keep the unit dry. Any liquid, i.e. rain, moisture, may destroy or damage the inside circuitry.
2. Don't use & store the unit in dusty places.
3. Don't put the unit in overheated or overcooled places.
4. Handle carefully. Don't vibrate or shake it violently.
5. Clear the unit with a piece of dry cloth. Don't clean in chemicals, detergent.
6. Don't paint the unit, this may cause some foreign materials left in between the parts.
7. Don't disassemble or refit the unit.
8. Please read the user manual carefully before installation and operation, learn something more about the voltage range. Otherwise, it won't work properly or destroy the product.

8. Faults & the Solutions

Faults	Solution
Fail to turn it on	Please check if built-in battery is charged, and power wires connected well.
No GSM signal	<ul style="list-style-type: none"> ● Please check if SIM card installed correctly. ● Please check if SIM card is GSM network.
No GPS	Please check if GPS antenna connected well, and recommend GPS antenna be installed near the window glass, no metal parts can cover it to make sure better GPS signal reception.
No reply to SMS command	Password wrong or the SMS format is wrong
Call without SMS reply or cannot receive alarm SMS	Authorized number is wrong or without setting any authorized number
Stop engine fail	Check the relay for engine cut is right connected.
Remote Controller fail	Remove external power , turn on the device and program again
Siren fail	Siren's voltage is DC12V/24V/1A. Siren can't be activated if it is negative triggered.